

Electra Slim Plus 15012

Product code: 01-009-007-12-150

RoHS
COMPLIANT

SELV



Input parameters:

Voltage range:	170~250 V AC
Frequency range:	50~60 Hz
AC current:	1.45 A / 230 V AC
Inrush current:	40A / 230VAC
Leakage current:	3mA / 230VAC
Standby power consumption:	<0.6W
Efficiency	87%
Power factor:	>0.55

Output parameters:

DC voltage:	12 V DC
Rated current:	12.5 A
Rated power:	150 W
Ripple&noise(max.):	<100mVp-p
Setup, rise time(max.):	1500ms, - / 230VAC
Hold up time	-
Load regulation:	±1%
Line regulation:	±1%
Regulation summary:	±2%

Environment:

Working Temp.&Humid.:	-25~50°C; 20~98% RH
Storage Temp.&Humid.:	-40~80°C; 10~98% RH
Vibration:	-
Max. Case Temperature:	80°C

Isolation:

Withstand voltage:	input-ouput:AC3.75KV
Isolation resistance	input-ouput: DC500V 100MΩ(at room temp. & humid.)

Protection:

Short circuit:	recovers automatically after fault condition is removed; hiccup mode
Over load:	over 110% of rating recovers automatically after fault condition is removed
Over voltage:	-
Over current:	-
Over Temperature:	-

Others:

IP:	IP67
Dimension:	279 x 57 x 25 mm
Power connection - wires:	input: 3x0.75mm² L200mm, output:: 2x.75mm² L200mm
Weight:	0.680 kg
Packing:	25 pcs
Warranty:	3

Block diagram:

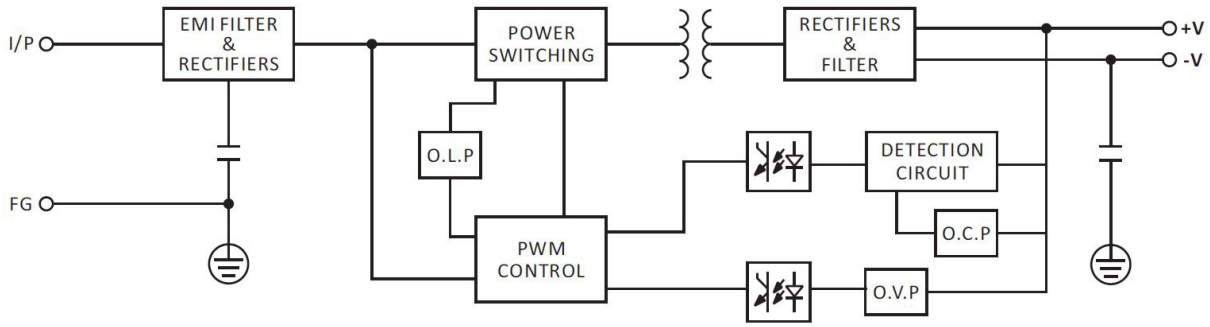

Dimensions [AxBxC]: 279 x 57 x 25 mm

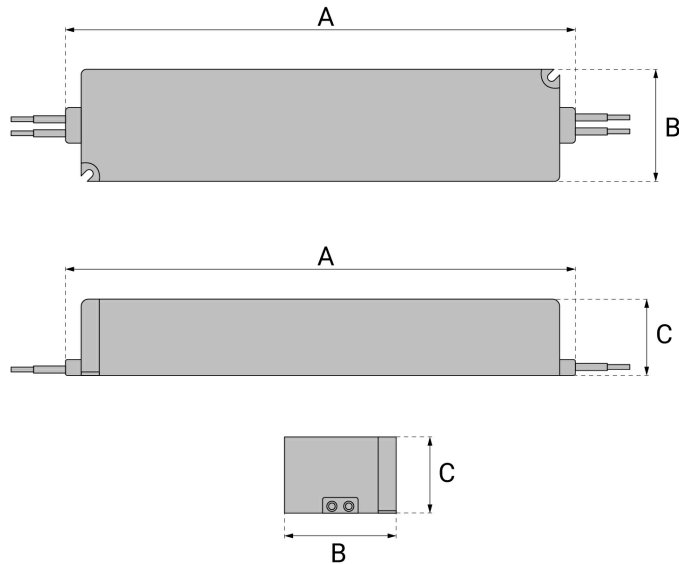

Derating curve:

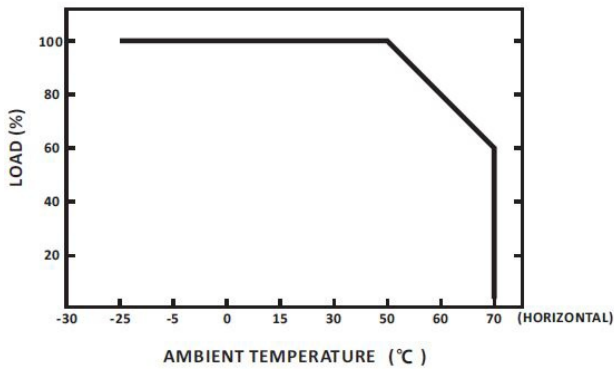

Static characteristics:

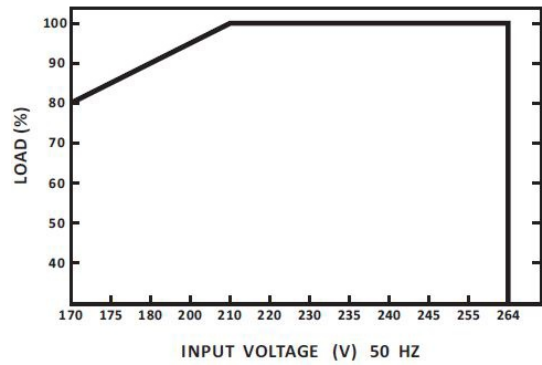

Note:

The given parameters (unless otherwise stated) were measured for a supply voltage of 230V AC, at nominal load in laboratory conditions, at an ambient temperature of 25°C.

The power supply is not an independently operating device, it is designed to work as a component of devices and installations. The EMC interference level of the power supply unit may depend on the nature of the receiver connected to it, and the total interference of the entire system also includes interference generated by other elements included in its composition.

The purpose of the power supply for LED lighting products may vary by region and local requirements. Before purchasing, verify the possibility of using the power supply to power LED products based on the legal requirements in the country of destination.